

SECURITHERM thermostatic basin mixer

Ref. H9726

Single hole, dual control tall mixer H. 205 L. 150





DESCRIPTION

SECURITHERM thermostatic basin mixer - Ref. H9726

SECURITHERM thermostatic dual control basin mixer. Tall, single hole mixer with swivelling spout H. 205mm L. 150mm with smooth interior. Spout with BIOSAFE hygienic outlet, suitable for fitting a BIOFIL filter. Anti-scalding failsafe: shuts off immediately if the cold or hot water supply fails. Scale-resistant thermostatic cartridge for temperature control. ¼-turn ceramic head for adjusting the flow rate. Temperature can be adjusted: cold water up to 41°C. Two temperature limiters: first temperature limiter set at to 38°C (can be overridden), and second temperature limiter set at 41°C. Thermal shocks are easy to undertake without removing the control knob or shutting off the cold water supply. Flow rate regulated at 5 lpm. ERGO control knobs. Ergonomic pop-up waste, 1 1/4" in brass. PEX flexibles F3/8" with filters and non-return valves. Fixing reinforced via 2 stainless steel rods. Thermostatic mixer ideal for healthcare facilities, retirement and care homes, hospitals and clinics. Mixer suitable for people with reduced mobility. Mixer with 30-year warranty.





TECHNICAL CHARACTERISTICS

SECURITHERM thermostatic basin mixer - Ref. H9726

Connector	F3/8"
Technology	SECURITHERM thermostatic mixer
Height	307mm
Drop height	205mm
Spout length	150mm
Flow rate	5 lpm
Temperature limiter	Yes
Finish	Chrome-plated brass
Norms	ACS    



ADVANTAGES

-  SECURITHERM: Optimum anti-scalding safety
-  Hygiene: smooth interior reduces bacteria
-  Thermostatic: total temperature stability
-  Thermal shock possible without removing the lever

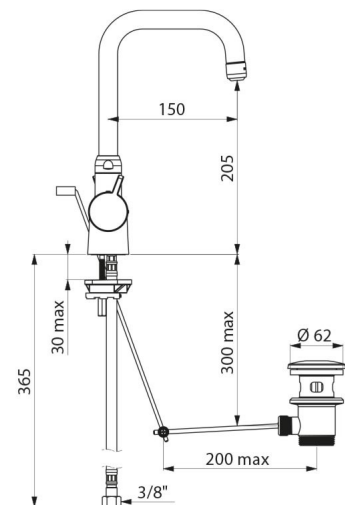

Warranty

30
YEAR
WARRANTY

Repairability

50
YEARS
REPAIRABILITY
