

SECURITHERM shower panel

Ref. H9636

Thermostatic shower panel with mixer with no non-return valves







DESCRIPTION

SECURITHERM shower panel - Ref. H9636



SECURITHERM shower panel made from anodised aluminium for wall-mounted exposed installation:
 SECURITHERM sequential thermostatic shower mixer.
 Thermostatic sequential mixer: opens and closes with cold water.
 Mixer without non-return valves (reduces bacterial proliferation).
 No risk of cross flow between the hot and cold water.
 Sequential mixer with anti-scalding failsafe: shuts off automatically if cold water supply fails.
 Cold water failsafe prevents cold showers: shuts off automatically if hot water supply fails.
 Adjustable temperature control from cold water up to 39°C.
 Maximum temperature limiter set at 39°C, can be adjusted.
 Thermal shocks are possible.
 Flow rate 9 lpm at 3 bar.
 Sliding handset on a chrome-plated riser rail with removable flexible hose via rapid push-fit STOP connector.
 Hygiene control lever L. 100mm.
 Top inlets with M1/2" stopcocks.
 Concealed fixings.
 Filters.
 Shower panel ideal for healthcare facilities, retirement and care homes, hospitals and clinics.
 Suitable for people with reduced mobility.
 Shower panel with 30-year warranty.

ADVANTAGES

-  SECURITHERM: Optimum anti-scalding safety
-  Maximum hygiene: no non-return valves
-  Thermostatic: total temperature stability
-  Sequential: opens/closes with cold water

TECHNICAL CHARACTERISTICS

SECURITHERM shower panel - Ref. H9636

Supply	Top inlets with M1/2" inline stopcocks
Connector	M1/2"
Technology	Sequential thermostatic shower mixer
Height	1045mm
Width	210mm
Flow rate	9 lpm
Temperature limiter	Yes
Finish	Aluminium
Norms	ACS  

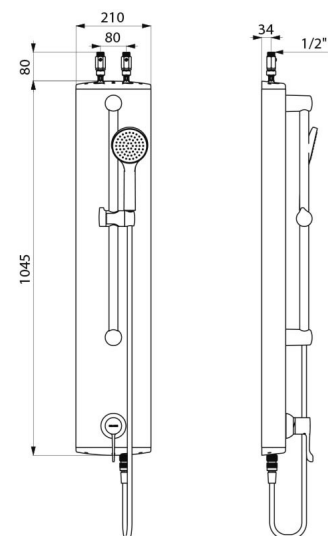

Warranty



Repairability

