

SECURITHERM thermostatic sink mixer set

Ref. H9613

Sequential mixer and column set

DESCRIPTION

SECURITHERM thermostatic sink mixer set - Ref. H9613

SECURITHERM thermostatic sequential sink mixer set and column with retracting hand spray.
Ideal for baby baths.
Anti-scalding failsafe: shuts off automatically if cold or hot water supply fails.
Securitouch thermal insulation prevents burns.
Sequential: opens and closes with cold water.
No risk of cross flow between the hot and cold water.
No non-return valves on the inlets.
Swivelling column H. 195mm L. 215mm.
Retracting hand spray with 2 jet options: flow straightener/rain effect.
Scale-resistant thermostatic sequential cartridge for single control temperature and flow-rate adjustment.
Temperature can be adjusted from cold water to 40°C with maximum temperature limiter set at 40°C.
Body and column with smooth interiors.
Flow rate regulated at 7 lpm.
No manual contact thanks to Hygiene control lever L. 100mm.
Mixed water brass outlet L. 160mm.
BIOSAFE flexible shower hose reduces bacterial proliferation: transparent polyurethane, smooth interior and exterior.
Hose with narrow diameter (internal Ø 6mm): low water volume.
Specific counterweight.
PEX flexibles F3/8" and reinforced fixing via 2 stainless steel rods.
Ideal for healthcare facilities, retirement and care homes, hospitals and clinics.
Suitable for people with reduced mobility.
30-year warranty.





TECHNICAL CHARACTERISTICS

SECURITHERM thermostatic sink mixer set - Ref. H9613



Connector	F3/8"
Technology	SECURITHERM sequential Securitouch
Drop height	195mm
Spout length	215mm
Flow rate	7 lpm
Temperature limiter	40°C

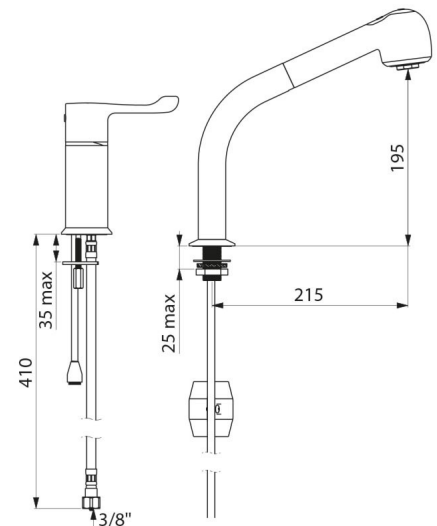

ADVANTAGES

-  Sequential: opens/closes with cold water
-  Hygiene: no non-return valves
-  SECURITHERM: Optimal anti-scalding safety
-  Sequential open and closing on cold water



Finish	Chrome-plated brass
Norms	ACS  
Warranty	
Repairability	