

SECURITHERM thermostatic sink mixer set

Ref. H9613

Sequential mixer and column set



DESCRIPTION

SECURITHERM thermostatic sink mixer set - Ref. H9613

SECURITHERM thermostatic sequential sink mixer set and column with retracting hand spray. Ideal for baby baths. Anti-scalding failsafe: shuts off automatically if cold or hot water supply fails. Securitouch thermal insulation prevents burns. Sequential: opens and closes with cold water. No risk of cross flow between the hot and cold water. No non-return valves on the inlets. Swivelling column H. 195mm L. 215mm. Retracting hand spray with 2 jet options: flow straightener/rain effect. Scale-resistant thermostatic sequential cartridge for single control temperature and flow-rate adjustment. Temperature can be adjusted from cold water to 40°C with maximum temperature limiter set at 40°C. Body and column with smooth interiors. Flow rate regulated at 7 lpm. No manual contact thanks to Hygiene control lever L. 100mm. Mixed water brass outlet L. 160mm. BIOSAFE flexible shower hose reduces bacterial proliferation: transparent polyurethane, smooth interior and exterior. Hose with narrow diameter (internal Ø 6mm): low water volume. Specific counterweight. PEX flexibles F3/8" and reinforced fixing via 2 stainless steel rods. Ideal for healthcare facilities, retirement and care homes, hospitals and clinics. Suitable for people with reduced mobility. 30-year warranty.





TECHNICAL CHARACTERISTICS

SECURITHERM thermostatic sink mixer set - Ref. H9613

Connector	F3/8"
Technology	SECURITHERM sequential Securitouch
Drop height	195mm
Spout length	215mm
Flow rate	7 lpm
Temperature limiter	40°C
Finish	Chrome-plated brass
Norms	ACS  



ADVANTAGES

-  Sequential: opens/closes with cold water
-  Hygiene: no non-return valves
-  SECURITHERM: Optimal anti-scalding safety
-  Sequential open and closing on cold water

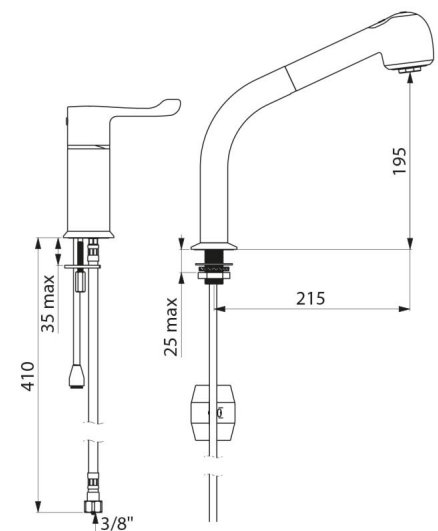

Warranty

30
YEAR
WARRANTY

Repairability

50
YEARS
REPAIRABILITY
