

# BIOSAFE mechanical basin mixer

Ref. 26216

Single hole mechanical mixer with no spout H. 95mm L. 110mm



## DESCRIPTION

**BIOSAFE mechanical basin mixer - Ref. 26216**

Deck-mounted mechanical basin mixer  
 Single hole mechanical mixer H. 95mm L. 110mm.  
 No spout: hygienic flow straightener integrated into the body.  
 Securitouch thermal insulation prevents burns.  
 Ø 35mm ceramic cartridge with pre-set maximum temperature limiter.  
 Thermal shocks are possible without removing the control lever or shutting off the cold water supply.  
 Body with smooth interior and very low water volume (reduces bacterial development).  
 Flow rate regulated at 5 lpm.  
 Solid control lever.  
 No pop-up waste.  
 Mixer with copper tails and stopcocks Ø 15mm.  
 Fixing reinforced by two stainless steel rods.  
 Mechanical mixer ideal for healthcare facilities, retirement and care homes, hospitals and clinics.  
 Single hole mixer suitable for people with reduced mobility.  
 Mixer with 30-year warranty.  
 Also available with PEX flexibles.





## TECHNICAL CHARACTERISTICS

**BIOSAFE mechanical basin mixer - Ref. 26216**

Connector	1/2"
Technology	BIOSAFE mechanical mixer
Height	180mm
Length	220mm
Drop height	95mm
Spout length	110mm
Flow rate	4 lpm
Temperature limiter	Yes
Finish	Chrome-plated brass
Norms	
Warranty	



## ADVANTAGES

-  Hygiene: body with very low water volume
-  Maximum hygiene: mixer with no spout
-  Thermal shocks are possible without removing lever
-  Pre-set maximum temperature limiter

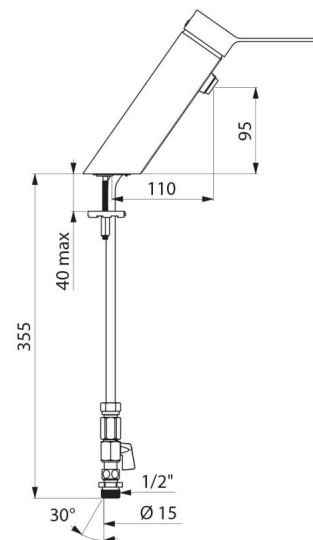

---

Repairability

