

SPORTING 2 SECURITHERM electronic shower panel

Ref. 714906

Battery-operated, thermostatic, scale-resistant nozzle





DESCRIPTION

SPORTING 2 SECURITHERM electronic shower panel - Ref. 714906





Thermostatic electronic shower panel - top inlets:
Anodised aluminium and chrome-plated satin finish panel.
Extra flat structure with concealed fixings.
Battery-operated with CR123 6V Lithium batteries.
Infrared presence detection. Shower starts when hand is moved towards the sensor (detection distance ~4cm).
Shuts off voluntarily or automatically after ~60 seconds.
Duty flush (~60 seconds every 24 hours after the last use).
Flow rate 6 lpm at 3 bar.
Tamperproof, scale-resistant fixed shower head with automatic flow rate regulation.
Accessible filters and non-return valves.
Integrated stopcocks.
M1½" connections for top inlets.
Electronic shower panel suitable for people with reduced mobility.
30-year warranty.
SECURITHERM technology:
Thermostatic shower mixer directly integrated in the head of the shower panel.
Temperature set by the installer.
Stable temperature, pre-set at 38°C.
Anti-scalding failsafe: automatic shut-off if the cold water fails.
Anti-cold showers function: automatic shut-off if the hot water fails.

TECHNICAL CHARACTERISTICS

SPORTING 2 SECURITHERM electronic shower panel - Ref. 714906

Supply	6V batteries
Connector	M1/2"
Technology	Electronic
Height	1020mm
Depth	21mm
Width	70mm
Flow rate	6 lpm
Finish	Aluminium
Norms	ACS   

ADVANTAGES

-  80% water savings
-  Anti-bacterial proliferation duty flush
-  Immediate shut-off if cold water fails
-  Streamlined design, concealed fixings

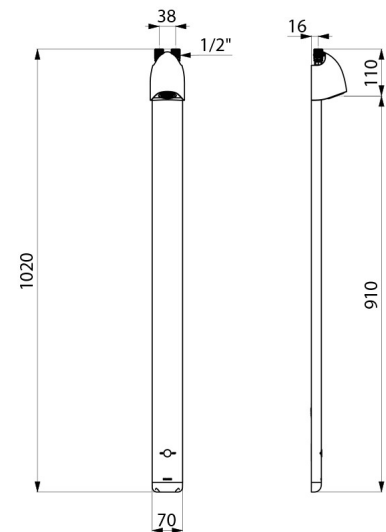

Warranty

