

# SPORTING 2 SECURITHERM electronic shower panel

Ref. 714906

Battery-operated, thermostatic, scale-resistant nozzle



## DESCRIPTION

**SPORTING 2 SECURITHERM electronic shower panel - Ref. 714906**

Thermostatic electronic shower panel - top inlets:  
Anodised aluminium and chrome-plated satin finish panel.  
Extra flat structure with concealed fixings.  
Battery-operated with CR123 6V Lithium batteries.  
Infrared presence detection. Shower starts when hand is moved towards the sensor (detection distance ~4cm).  
Shuts off voluntarily or automatically after ~60 seconds.  
Duty flush (~60 seconds every 24 hours after the last use).  
Flow rate 6 lpm at 3 bar.  
Tamperproof, scale-resistant fixed shower head with automatic flow rate regulation.  
Accessible filters and non-return valves.  
Integrated stopcocks.  
M1/2" connections for top inlets.  
Electronic shower panel suitable for people with reduced mobility.  
30-year warranty.  
SECURITHERM technology:  
Thermostatic shower mixer directly integrated in the head of the shower panel.  
Temperature set by the installer.  
Stable temperature, pre-set at 38°C.  
Anti-scalding failsafe: automatic shut-off if the cold water fails.  
Anti-cold showers function: automatic shut-off if the hot water fails.





## TECHNICAL CHARACTERISTICS

**SPORTING 2 SECURITHERM electronic shower panel - Ref. 714906**

Supply	6V batteries
Connector	M1/2"
Technology	Electronic
Height	1020mm
Depth	21mm
Width	70mm
Flow rate	6 lpm
Finish	Aluminium
Norms	ACS   



## ADVANTAGES

-  80% water savings
-  Anti-bacterial proliferation duty flush
-  Immediate shut-off if cold water fails
-  Streamlined design, concealed fixings

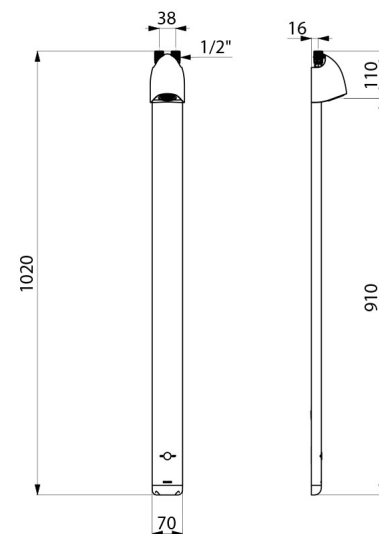

---

Warranty

