

SECURITHERM EP BIOSAFE pressure-balancing basin mixer

Ref. 2621MINIEP

Single hole mechanical mixer with no spout H. 50mm L. 80mm







DESCRIPTION

SECURITHERM EP BIOSAFE pressure-balancing basin mixer - Ref. 2621MINIEP

Deck-mounted mechanical basin mixer with pressure-balancing. Single hole mechanical mixer H. 50mm L. 80mm. No spout: BIOSAFE hygienic outlet integrated into the body. Ø 35mm ceramic cartridge with pressure-balancing and pre-set maximum temperature limiter. Anti-scalding safety: HW flow rate is reduced if CW supply fails (and vice versa). Stable temperature regardless of pressure and flow rate variations in the system. Securitouch thermal insulation prevents burns. Thermal shocks are possible without removing the control lever or shutting off the cold water supply. Mixer body with smooth interior and very low water volume (reduces bacterial development). Flow rate limited to 4 lpm at 3 bar. Solid control lever. No pop-up waste. PEX flexibles F3/8" with rotating unions with filters and non-return valves. Fixing reinforced by two stainless steel rods. Mechanical mixer with SECURITHERM pressure-balancing ideal for healthcare facilities, retirement and care homes, hospitals and clinics. Single hole mixer suitable for people with reduced mobility. Mixer with 30-year warranty. Also available with copper tails.

TECHNICAL CHARACTERISTICS

SECURITHERM EP BIOSAFE pressure-balancing basin mixer - Ref. 2621MINIEP

Connector	F3/8"
Technology	SECURITHERM EP BIOSAFE mechanical mixer
Drop height	50mm
Spout length	80mm
Flow rate	4 lpm at 3 bar
Temperature limiter	Yes
Norms	     
Warranty	



ADVANTAGES



HW flow rate reduced if CW fails



Maximum hygiene: mixer with no spout



Thermal shocks are possible without removing lever



Hygiene: body with very low water volume

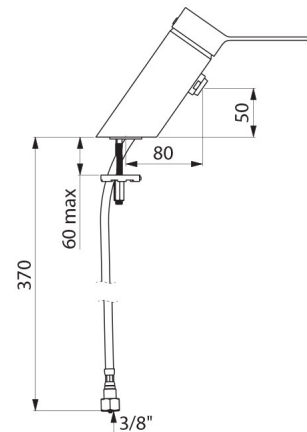

Repairability

