

Shower kit with thermostatic mixer

Ref. H9630KIT

Riser kit with thermostatic mixer with no non-return valves

2024 UK public price excluding VAT: £477.03



DESCRIPTION





Shower kit with thermostatic mixer - Ref. H9630KIT

Shower riser kit with thermostatic sequential mixer.
 Shower riser rail with SECURITHERM thermostatic shower mixer.
 Thermostatic sequential mixer: opens and closes with cold water.
 Mixer with no non-return valves on the inlets (reduces bacterial proliferation).
 No risk of cross flow between hot and cold water.
 Sequential mixer with anti-scalding failsafe: shuts off automatically if cold or hot water supply fails.
 Securitouch thermal insulation prevents burns.
 Scale-resistant, thermostatic sequential cartridge:
 Temperature control from cold water up to 39°C with maximum temperature limiter set at 39°C.
 Thermal shocks are possible.
 Body with smooth interior and low water volume.
 Flow rate regulated at 9 lpm.
 Chrome plated brass body and Hygiene lever L. 100mm.
 M1/2" bottom shower outlet.
 Wall-mounted mixer with offset STOP/CHECK connectors, M1/2" M3/4".
 Mixer ideal for healthcare facilities, retirement and care homes, hospitals and clinics

- Sliding shower head holder (ref. 813) on a chrome-plated riser rail (ref. 821) with soap dish and flexible shower hose (ref. 836T1).
- Shower head retaining collar (ref. 830).



Suitable for people with reduced mobility.
 30-year warranty.

ADVANTAGES

-  Sequential: opens/closes with cold water
-  Maximum hygiene: no non-return valves
-  SECURITHERM: optimal anti-scalding safety
-  Thermostatic: complete temperature stability

TECHNICAL CHARACTERISTICS

Shower kit with thermostatic mixer - Ref. H9630KIT

Connector	M1/2"
Technology	SECURITHERM single control, Securitouch
Depth	185mm
Length	184mm
Flow rate	9 lpm
Temperature limiter	39°C
Finish	Chrome-plated brass
Norms	ACS 
Warranty	

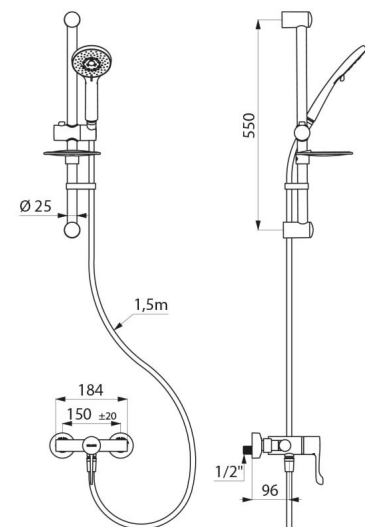

Repairability

