

Aluminium shower panel with SECURITHERM sequential mixer

Ref. H963615

Thermostatic shower panel with mixer and no non-return valves

2024 UK public price excluding VAT: £829.60

DESCRIPTION

Aluminium shower panel with SECURITHERM sequential mixer - Ref. H963615

SECURITHERM anodised aluminium shower panel for wall-mounted exposed installation.
 SECURITHERM thermostatic sequential shower mixer (non-time flow).
 Thermostatic sequential shower mixer: opens and closes with cold water.
 Mixer with no non-return valves on the inlets (reduces bacterial proliferation).
 No risk of cross flow between the hot and cold water.
 Sequential mixer with anti-scalding failsafe: shuts off automatically if cold water supply fails.
 Cold water failsafe prevents cold showers: shuts off automatically if hot water supply fails.
 Temperature control from cold water up to 39°C.
 Temperature limiter set at 39°C, can be adjusted.
 Thermal shocks are possible.
 Flow rate 9 lpm at 3 bar.
 Sliding handset on chrome-plated rail with flexible shower hose removable with push fit rapid STOP connector.
 Hygiene control lever L. 100mm.
 Top inlets with M1/2" inline stopcocks.
 Copper tubes.
 Concealed fixings. Filters.
 Shower panel suitable for healthcare facilities, retirement and care homes, hospitals and clinics.
 Suitable for people with reduced mobility.
 30-year warranty.





TECHNICAL CHARACTERISTICS

Aluminium shower panel with SECURITHERM sequential mixer - Ref. H963615

Supply	Top inlets via inline stopcocks M1/2"
Connector	M1/2", Ø 15mm
Technology	SECURITHERM single control thermostatic mixer
Height	1045mm
Width	210mm
Flow rate	9 lpm
Temperature limiter	39°C
Finish	Aluminium



ADVANTAGES

-  SECURITHERM: Optimum anti-scalding safety
-  Maximum hygiene: no non-return valves
-  Thermostatic: total temperature stability
-  Sequential: open and closing on cold water

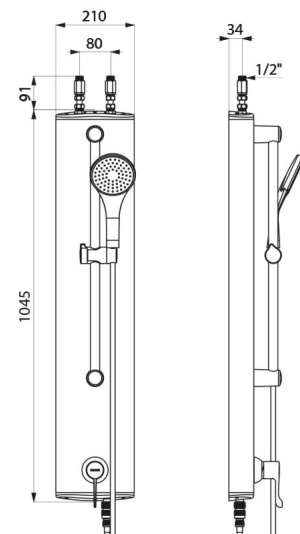

Warranty

