

# Sequential mechanical basin mixer

Ref. 2641

Sequential mechanical mixer with swivel/fixed spout L. 200mm

2025 UK public price excluding VAT: £396.15







## DESCRIPTION

### Sequential mechanical basin mixer - Ref. 2641









Wall-mounted sequential mechanical basin mixer.  
 Sequential mechanical mixer: opens and closes with cold water, with 70° turning range.  
 Wall-mounted mixer with swivelling under spout L. 200mm with hygienic BIOSAFE outlet.  
 Spout suitable for fitting a BIOFIL point-of-use filter.  
 Spout can be easily fixed in place.  
 Securitouch thermal insulation prevents burns.  
 Ø 35mm standard ceramic cartridge with pre-set maximum temperature limiter.  
 Body and spout with narrow tubes with smooth interiors and very low water volume.  
 The speed that the water flows through these tubes reduces the development of biofilm considerably.  
 Thermal shocks are possible without removing the control lever or shutting off the cold water supply.  
 Flow rate regulated at 4 lpm.  
 Chrome-plated brass body.  
 Hygiene control lever L. 150mm requires no manual contact.  
 Mixer with 150mm centres supplied with offset STOP/CHECK wall connectors M1/2" M3/4" ideal for hospitals.  
 Recommended installation height: 110 - 200mm above the basin surface.  
 Mechanical mixer ideal for healthcare facilities, retirement and care homes, hospitals and clinics.  
 Sequential mixer suitable for people with reduced mobility.  
 Mixer with 30-year warranty.

## ADVANTAGES

-  Sequential: opens/closes with cold water
-  Thermal shocks are possible without removing lever
-  Sequential: opens/closes with cold water
-  Spout can be fixed or swivel

## TECHNICAL CHARACTERISTICS

### Sequential mechanical basin mixer - Ref. 2641

Connector	M1/2"
Technology	BIOSAFE sequential mechanical mixer
Spout length	200mm
Flow rate	4 lpm
Temperature limiter	Yes
Finish	Chrome-plated brass
Norms	      
Warranty	

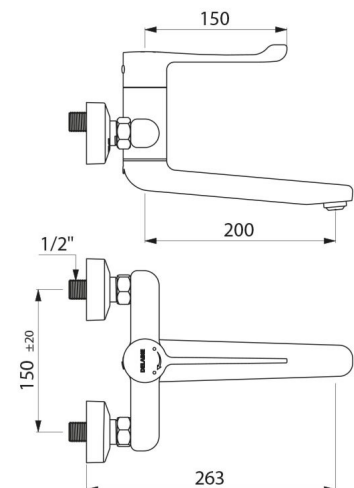

---

Repairability

