

SECURITHERM EP BIOSAFE pressure balancing basin mixer

Ref. 2621EP

Single hole mechanical mixer with no spout, H. 95mm L. 110mm

2025 UK public price excluding VAT: £229.28

DESCRIPTION

SECURITHERM EP BIOSAFE pressure balancing basin mixer - Ref. 2621EP

Deck-mounted mechanical basin mixer with pressure-balancing. Single hole mechanical mixer H. 95mm L. 110mm. No spout: hygienic flow straightener integrated into the body. Ø 35mm ceramic cartridge with pressure-balancing and pre-set maximum temperature limiter. Anti-scalding safety: HW flow rate is reduced if CW supply fails (and vice versa). Stable temperature regardless of pressure and flow rate variations in the system. Securitouch thermal insulation prevents burns. Thermal shocks are possible without removing the control lever or shutting off the cold water supply. Mixer body with smooth interior and very low water volume (reduces bacterial development). Flow rate limited to 4 lpm at 3 bar. Solid control lever. With no pop-up waste. PEX flexibles F3/8" with rotating unions, filters and non-return valves. Fixing reinforced by two stainless steel rods. Mechanical mixer with SECURITHERM pressure-balancing ideal for healthcare facilities, retirement and care homes, hospitals and clinics. Single hole mixer suitable for people with reduced mobility. Mixer with 30-year warranty. Also available with copper tails.





TECHNICAL CHARACTERISTICS

SECURITHERM EP BIOSAFE pressure balancing basin mixer - Ref. 2621EP

Connector	F3/8"
Technology	SECURITHERM EP BIOSAFE mechanical mixer
Height	180mm
Length	220mm
Drop height	95mm
Spout length	110mm
Flow rate	4 lpm at 3 bar
Temperature limiter	Yes
Finish	Chrome-plated stainless steel



ADVANTAGES

-  HW flow rate reduced if CW fails
-  Maximum hygiene: mixer with no spout
-  Thermal shocks are possible without removing lever
-  Hygiene: body with very low water volume

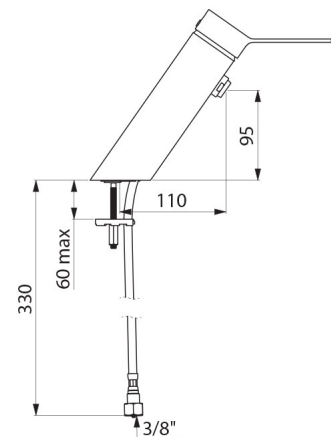

Norms



Warranty



Repairability

