

# Wall-mounted sequential mechanical basin mixer

Ref. 2644P

Sequential mechanical mixer with swivelling/fixed spout L. 120mm

2024 UK public price excluding VAT: £372.89







## DESCRIPTION

Wall-mounted sequential mechanical basin mixer - Ref. 2644P



Wall-mounted sequential mechanical basin mixer.  
 Sequential mechanical mixer: opens and closes with cold water, with 70° lever turning range.  
 Wall-mounted mixer with swivelling under spout L. 120mm with hygienic BIOSAFE outlet.  
 Spout suitable for fitting a BIOFIL point-of-use filter.  
 Spout can be easily fixed in place.  
 Securitouch thermal insulation prevents burns.  
 Ø 35mm classic ceramic cartridge with pre-set maximum temperature limiter.  
 Body and spout with narrow tubes with smooth interiors and very low water volume.  
 The speed of the water in these narrow tubes reduces biofilm development considerably.  
 Thermal shocks are possible without removing the control lever or shutting off the cold water supply.  
 Flow rate regulated at 5 lpm.  
 Chrome-plated brass body.  
 Hygiene Lever L. 150mm requires no manual contact.  
 Mixer with 200mm centres supplied with in-line STOP/CHECK wall connectors M1/2" M3/4" ideal for hospitals.  
 Recommended installation height: 110 - 200mm above the basin surface.  
 Mechanical mixer ideal for healthcare facilities, retirement and care homes, hospitals and clinics.  
 Sequential mixer suitable for people with reduced mobility.  
 30-year warranty.

## ADVANTAGES

-  Sequential: opens/closes with cold water
-  Thermal shocks are possible without removing lever
-  Maximum hygiene: prevents biofilm
-  Spout can swivel or be fixed

## TECHNICAL CHARACTERISTICS

Wall-mounted sequential mechanical basin mixer - Ref. 2644P

Supply	M1/2"
Technology	BIOSAFE sequential mechanical mixer
Spout length	120mm
Flow rate	5 lpm
Temperature limiter	YES
Finish	Chrome-plated brass
Norms	
Warranty	

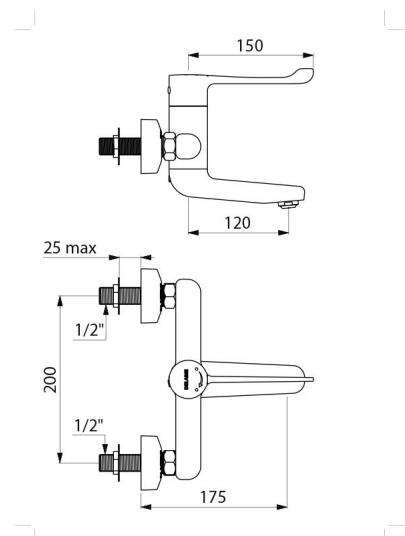

---

Repairability

